



**International Shooting Sport
Federation
And
USA SHOOTING**



RIFLE RULES

FOR

300 m Rifle

300 m Standard Rifle

50 m Rifle

10 m Air Rifle

Edition 2011 (First Printing, 11/2008)

Effective 1 February 2011



CHAPTERS

7.1	GENERAL	- 304 -
7.2	SAFETY	- 304 -
7.3	RANGE AND TARGET STANDARDS	- 304 -
7.4	EQUIPMENT AND AMMUNITION	- 304 -
7.5	SHOOTING EVENT PROCEDURES AND COMPETITION RULES.	- 319 -
7.6	RIFLE EVENTS	- 321 -
7.7	SCORING PROCEDURES – Indication of shots 300 m.....	- 321 -
7.8	RIFLE EVENT TABLE	- 324 -
7.9	RIFLE SPECIFICATION TABLE.....	- 325 -
7.10	INDEX RIFLE RULES	- 326 -

Note: Where figures and tables contain specific information, these have the same authority as the numbered rules.



7.1 GENERAL

7.1.1 These Rules are part of the Technical Rules of the ISSF and apply to all rifle events.

7.1.2 All shooters, team leaders and officials must be familiar with the ISSF Rules and must ensure that these Rules are enforced. It is the responsibility of each shooter to comply with the Rules.

USA 7.1.2A All shooters, team leaders and officials must be familiar with all USA Shooting rules and must ensure that these rules are enforced.

7.1.3 When a Rule refers to right-handed shooters, the reverse of that Rule refers to left-handed shooters.

7.1.4 Unless a Rule applies specifically to a men's or a women's event, it must apply uniformly to both men's and women's events.

7.2 SAFETY

SAFETY IS OF PARAMOUNT IMPORTANCE

See Technical Rules – Section 6.

7.3 RANGE AND TARGET STANDARDS

Target and range standards may be found in the Technical Rules – Section 6.

7.4 EQUIPMENT AND AMMUNITION

See Technical Rules – Section 6.

7.4.1 Standards for all Rifles

7.4.1.1 Pistol Grips. The pistol grip for the right hand must not be constructed in such a way that it rests on the sling or on the left arm.

7.4.1.2 Barrels and extension tubes must not be perforated in any way. Any construction or device inside the barrel or tubes, other than rifling and chambering for the cartridge or pellet, is prohibited.

7.4.1.2.1 Compensators and muzzle brakes on rifles are prohibited.

7.4.1.3 Sights

7.4.1.3.1 Correcting lenses and telescopes must not be attached to the rifle.

7.4.1.3.2 Correction glasses, and/or filters, may be worn by the shooter.

7.4.1.3.3 Any sight not containing a lens or system of lenses is permitted. Light filters may be fitted to the front or rear sight, or both.

7.4.1.3.4 A blinder may be attached to the rifle or to the rear sight. The blinder must not be more than 30 mm deep (A) nor extend further than 100 mm (B) from the center of the rear sight aperture on the side of the non aiming eye. A blinder must not be used on the side of the aiming eye.



7.4.1.3.4.1 Blinder on rear sight

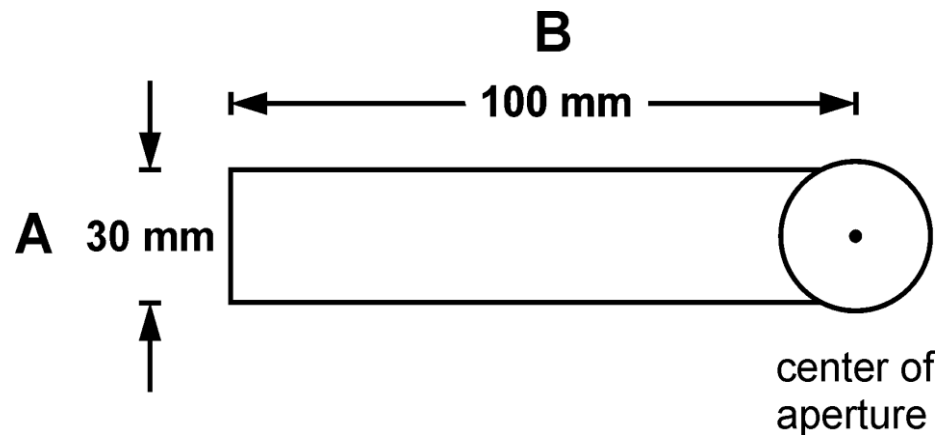

7.4.1.3.5 A prism or mirror device may be used when shooting from the right shoulder while aiming with the left eye or vice versa providing it does not have a magnifying lens or lenses. It must not be used when shooting from the right shoulder when using the right eye or from the left shoulder when using the left eye.

7.4.1.4 **Electronic triggers** are allowed providing:

7.4.1.4.1 all their components are firmly attached to and contained within the action or stock of the rifle;

7.4.1.4.2 the trigger is operated by the right hand of a right handed or the left hand of a left handed shooter;

7.4.1.4.3 all components are included when the rifle is submitted for inspection by the Equipment Control Section;

7.4.1.4.4 the rifle with all components installed complies with the rules governing dimensions and weight for that event.

7.4.1.4.5 **Slings**

Maximum sling width is 40 mm. The sling must be worn only over the upper part of the left arm and from there be connected to the forend of the rifle stock. These slings may be attached to the forend of the rifle at a single point only. The sling must pass along one side of the hand or wrist only. No part of the rifle may touch the sling or any of its attachments except at the sling swivel and hand stop.

7.4.2 **Standards for 300 m Standard Rifle and 10 m Air Rifle**

7.4.2.1 The butt plate may be adjustable up or down. The lowest point of the stock or toe of the butt plate, with the butt plate in its maximum downward position must not exceed 220 mm from the center line of the barrel. It may be offset parallel to the center line of the normal end of the butt plate left or right a maximum 15 mm OR the complete butt plate (not part) may be turned on the vertical axis. Turning the butt plate on the horizontal axis is not permitted.



7.4.2.1.1

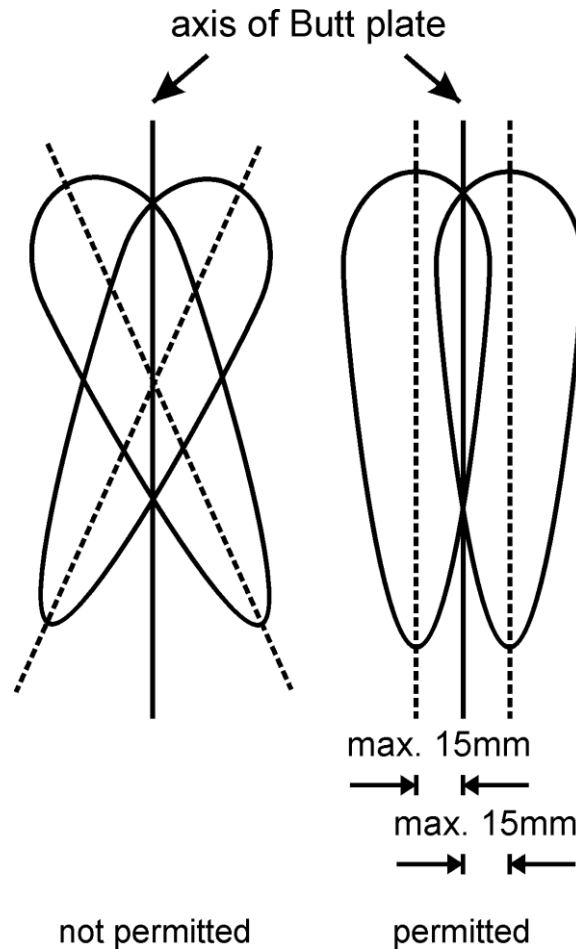

7.4.2.2

A thumb hole, thumb rest, palm rest, heel rest and spirit level are prohibited. If a stock is less than the maximum allowed in any dimension, it may be brought up to the measurements shown in the Rifle Measurement Table. Any addition must be within the permitted dimensions and in no case may the pistol grip or the lower part of the stock be anatomically formed.

7.4.2.2.1

Material that gives increased grip may not be added to the forend, pistol grip or lower part of the stock.

7.4.2.2.2

A heel rest is any protrusion or extension on the front or side of the pistol grip designed to prevent the hand from slipping.

7.4.2.3

Exterior Weights

7.4.2.3.1

Only barrel weights within a radius of 30 mm from the center of the barrel are permitted. Barrel weights may be moved along the barrel.

7.4.2.3.2

Any other weights must be within the dimensions of the stock.



7.4.2.4 300 m Standard Rifle

All 300 m rifles which conform to the specifications shown in the Rifle Measurements Table and with the following additional restrictions.

7.4.2.4.1 The minimum trigger pull is 1500 grams. The trigger pull must be measured with the barrel in a vertical position. Trigger weight control checks must be conducted immediately after the last series. A maximum of three (3) attempts to lift the weight is allowed. Any shooter whose rifle fails the test must be disqualified.

7.4.2.4.2 The rifle must not be removed from the firing line during the course of fire except with the permission of range officials.

7.4.2.4.3 The same rifle must be used in all positions without change. This does not refer to adjustment of the butt plate and hand stop or to the changing of front sight inserts or to adjustment of the rear sight or its eyepiece. The removal of the cheek piece during competition is permitted for barrel cleaning and bolt removal under supervision of the Jury; but its position must not be changed when it is replaced.

7.4.2.4.4 The overall length of the barrel including any extension tube, measured from the breech face to the apparent muzzle, must not exceed 762 mm.

7.4.2.5 10 m Air Rifle

7.4.2.5.1 Any type of compressed air or gas rifle which conforms to the specifications shown in the Rifle Measurements Table and with the following additional restrictions:

7.4.2.5.2 The total length of the air rifle system measured from the back end of the mechanism to the apparent muzzle must not exceed 850 mm.



7.4.2.6

Rifle Measurement Table

Front sight not to extend beyond the apparent muzzle

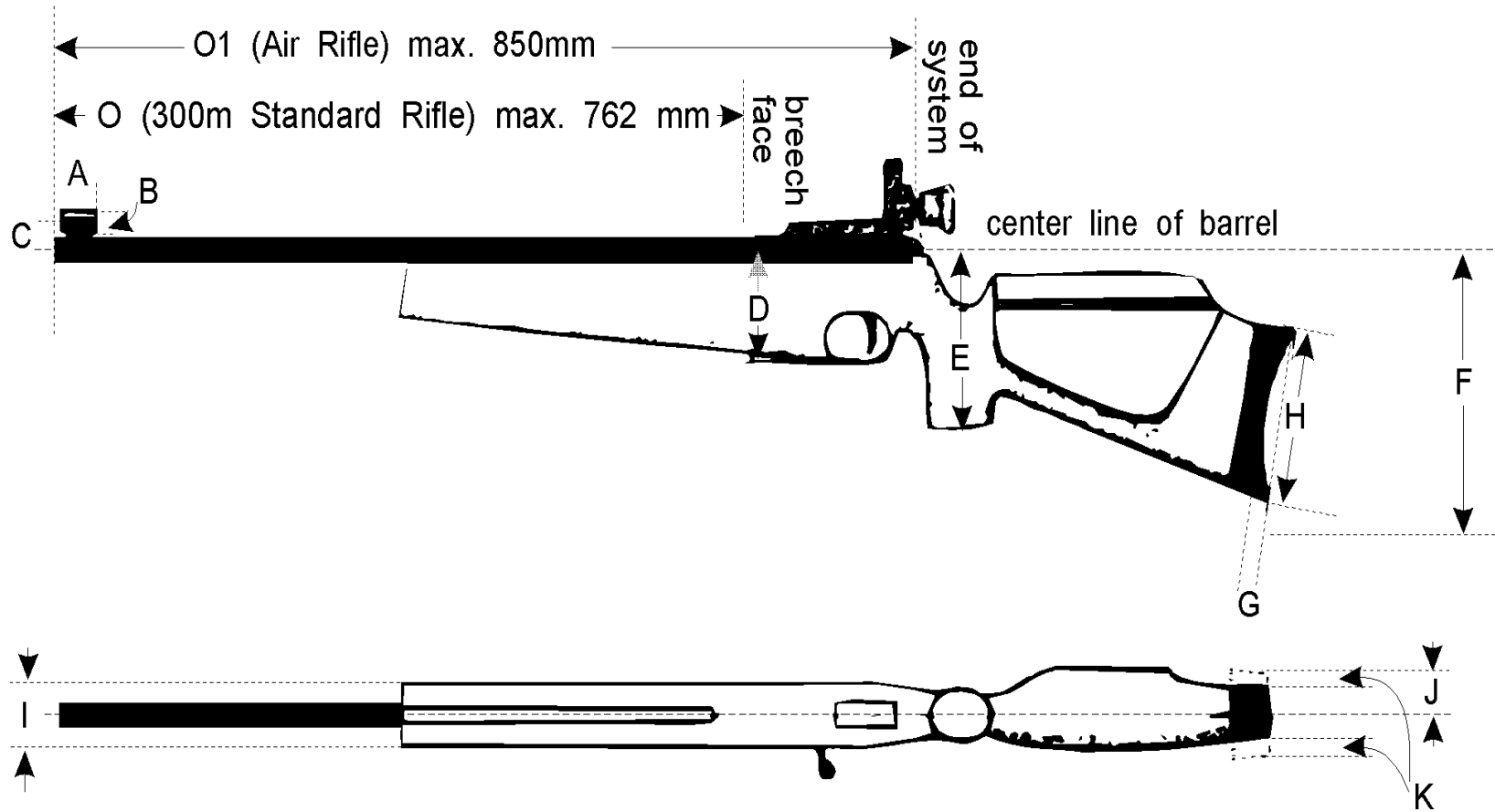



7.4.2.7 Measurements for Dimensions C, D, E, F, and J, are from Center line of Barrel

		300 m Standard Rifle	Air Rifle
A	Length of front sight tunnel	50 mm	50 mm
B	Diameter of front sight tunnel	25 mm	25 mm
C	Distance from center of the front sight ring or top of post to center of bore either directly above or offset (except for those shooters firing from the right shoulder but using their left eye).	60 mm	60 mm
D	Depth of fore-end	90 mm	90 mm
E	Lowest point of pistol grip	160 mm	160 mm
F	Lowest point of stock or toe of butt plate with the butt plate in its maximum downward position	220 mm	220 mm
G	Depth of curve of butt plate	20 mm	20 mm
H	Heel to toe length of butt plate	153 mm	153 mm
I	Maximum thickness (breadth) of fore-end	60 mm	60 mm
J	Maximum distance of cheek piece from center line of barrel	40 mm	40 mm
K	Offset of butt plate parallel to the center line of the normal end of the butt left or right.	15 mm	15 mm
L	Trigger weight - No Set Trigger	1500 grams minimum	Free
M	Weight with sights (and hand stop 300 m)	5.5 kg	5.5 kg
N	The front sight must not extend beyond the apparent muzzle of the rifle of both, 300 m Standard and Air Rifle	Must not extend	Must not extend
O	Standard Rifle: The overall length of the barrel including extension (from the muzzle to the breech face)	762 mm	---
O1	Air Rifle: Total length of the Air Rifle system	---	850 mm



7.4.3 50 m Rifle

All rifles chambered for rim fire 5.6 mm (.22") Long Rifle cartridges are permitted, provided they do not exceed the following additional limitations.

7.4.3.1 The weight of the rifle must not exceed 8 kg for men or 6.5 kg for women with all accessories used including palm rest or hand stop.

7.4.3.2 Butt plate and Hook

A butt hook may be used that projects not more than 153 mm (A) past the rear of a line, perpendicular to a line drawn through the axis of the bore of the rifle, which is at a tangent to the deepest part of the butt plate depression that normally rests against the shoulder. It must have a total outside length around any curve or bend of not more than 178 mm (B).

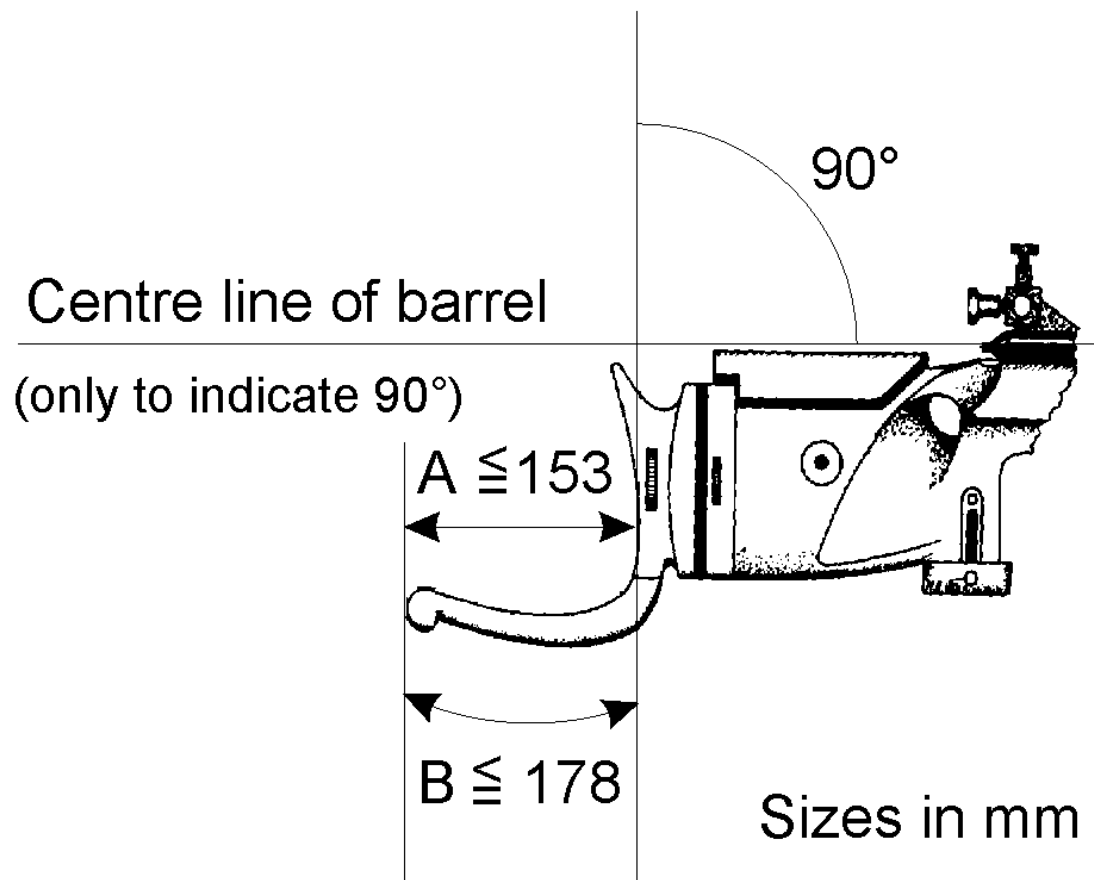

7.4.3.3 Palm Rest:

A palm rest is any attachment or extension below the fore-end which aids the support of the rifle by the forward hand. The palm rest must not extend more than 200 mm below the center line of the barrel.

7.4.3.4 More than one (1) rifle or parts of a rifle may be used.

7.4.4 300 m Rifle

Same as Rule for the 50 m Rifle (men and women). See Rifle Specification Table.



7.4.5 Ammunition

Rifle	Caliber	Other specifications
50 m	5.6 mm (.22")	Rim fire Long Rifle. Only bullets made of lead or similar soft material are permitted.
10 m	4.5 mm (.177")	Projectiles of any shape made of lead or other soft material are permitted.
300 m	Maximum 8 mm	Ammunition of any description that may be fired without any danger to shooters or range personnel. Tracer, armor piercing, and incendiary ammunition is prohibited.

7.4.6 Clothing Regulations

7.4.6.1 All equipment and apparel may be inspected on a one-time only basis at an ISSF World Championship or World Cup. Equipment Control certification must be retained with inspected equipment for presentation. Any inspected equipment or apparel that is changed must be re-inspected.

7.4.6.2 All shooting jackets, shooting trousers and shooting gloves must be made of flexible material that does not materially change its physical characteristics, that is, become stiffer, thicker or harder, under commonly accepted shooting conditions. All lining, padding and reinforcements must meet the same specifications. Any lining or padding must not be quilted, cross-stitched, glued or otherwise affixed to the outer clothing layer other than at normal tailoring points. All lining or padding must be measured as a part of the clothing.

7.4.6.2.1 Only one (1) shooting jacket, only one (1) pair of shooting trousers and only one (1) pair of shooting shoes may be approved by Equipment Control for each shooter for all rifle events in any ISSF supervised Competitions / Championships. If a shooter has more than one (1) item of rifle clothing (jacket, trousers and shooting shoes) which has been passed by Equipment Control then he must declare which item will be used for this championship. This does not prevent the shooter using ordinary trousers or normal athletic type training shoes in any event or position. The jacket must be capable of being used in all three positions (prone, standing and kneeling) and must meet all other specifications in order to be approved for the competition. Any item of clothing which fails to pass at Equipment Control may be retested without removing the item of clothing from the Equipment Control room. A third test may be conducted after the second test without the item of clothing being removed from the Equipment Control room. If the item of clothing fails to pass the Equipment Control on the third (3rd) test it may not be resubmitted and must be indelibly marked, unless permanent alterations are made.

7.4.6.2.1.1 Only one (1) substitute shooting jacket and only one (1) substitute shooting trousers may be submitted. Should a substitute item fail the test, no special clothing for that item may be worn.



7.4.6.2.1.2 Before and during tests the clothing must not be temporarily manipulated by heat or other means. Permanent alterations to clothing may be made. Clothing items may be removed from Equipment Control for this purpose and resubmitted.

7.4.6.2.1.3 Manipulation of the material after examination (sprays, etc.) will be penalized according to the rules.

7.4.6.3 Shooting Shoes

Normal street type or light athletic shoes, and shooting shoes not exceeding the following specifications are permitted:

7.4.6.3.1 The material of the upper part (above the line of the sole) must be of soft, flexible, pliable material, not thicker than 4 mm, including all linings, when measured on any flat surfaces such as point D in the Figure of the Shoe.

7.4.6.3.2 The sole must be flexible at the ball of the foot.

7.4.6.3.3 The height of the shoe from the floor to the highest point (Dimension C, Shooting Shoe Table) must not exceed two thirds (2/3) of the length (Dimension B+10 mm).

(Example: If the shoe length is 290 mm (B) add the 10 mm (E) and the total length are counted as 300 mm, therefore the height (C) must not be more than 200 mm).

7.4.6.3.4 If a shooter wears shoes, they must be a matched pair externally but see Shooting Shoe Table.

7.4.6.3.4.1 All shooter must walk normally while wearing their shooting shoes and trousers anywhere on the range. Normal walking means heel down first – then heel up (the heel lifts off of the floor must be visible) before lifting the toe. Normal walking also means bending the legs at the knees while walking. A warning will be given to a shooter for a first offense. A two (2) point penalty for the second offense and disqualification for the third offense on any competition day.

7.4.6.3.2 Figure of the Shoe

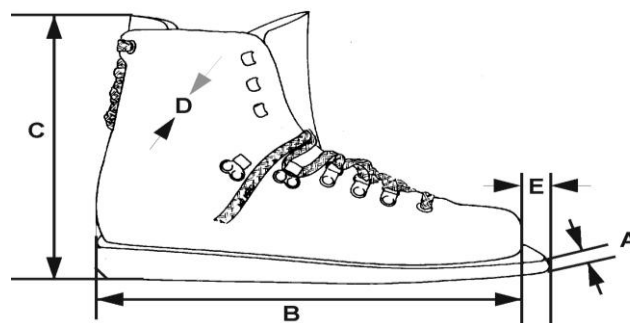

A.	Maximum thickness of sole at the toe: 10 mm.
B.	Overall length of shoe: According to size of wearer's foot.
C.	Maximum height of shoe: Not to exceed two-thirds (2/3) length of B+10 mm.



D.	Upper part of shoe material maximum thickness 4 mm.
E.	The extension of the toe of the sole must be not more than 10 mm in the front of the shoe and may be cut at an angle on the soles of either or both shoes. No other extension of the sole in length and width is permitted.

7.4.6.4 Measuring Devices

7.4.6.4.1 Thickness

The device used to measure the thickness of clothing and shoes must be capable of measuring to one-tenth of a millimeter (0.1 mm). Measurements must be taken with a 5 kg weight (load) applied. The device must have two (2) circular flat surfaces each 30 mm in diameter facing each other.

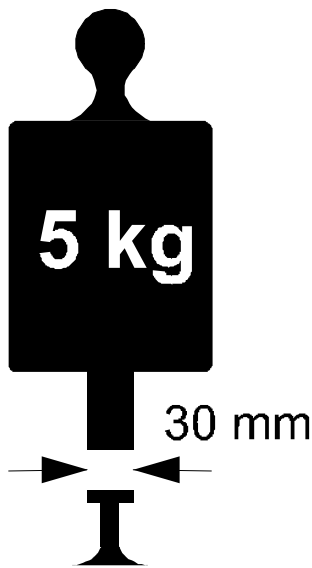

7.4.6.4.1.1 Thickness – Table

		Jackets	Trousers	Shoes	Gloves	Under-wear
	single thickness	2.5 mm	2.5 mm	4.0 mm	—	2.5 mm
	double thickness	5.0 mm	5.0 mm	—	—	5.0 mm
	total thickness	—	—	—	12.0 mm	—
Reinforcements	single thickness	10.0 mm	10.0 mm	—	—	—
Reinforcements	double thickness	20.0 mm	20.0 mm	—	—	—



7.4.6.4.2 Stiffness – The Stiffness for clothing will be measured by a suitable device approved by the ISSF.

7.4.6.4.2.1 Stiffness

The device used to measure the stiffness of clothing must be capable of measuring to one tenth of a millimeter (0.1 mm) and have the following dimensions:

A	Measuring cylinder	=	60 mm diameter
B	Measuring weight	=	1000 g (including grip and measuring plate C)
C	Measuring plate	=	20 mm diameter
D	Digital display		indicating 0.1 mm
E	The rounding of the edges on the measuring plate (C) and measuring cylinder (A) must not be more than 0.5 mm radius as maximum.		

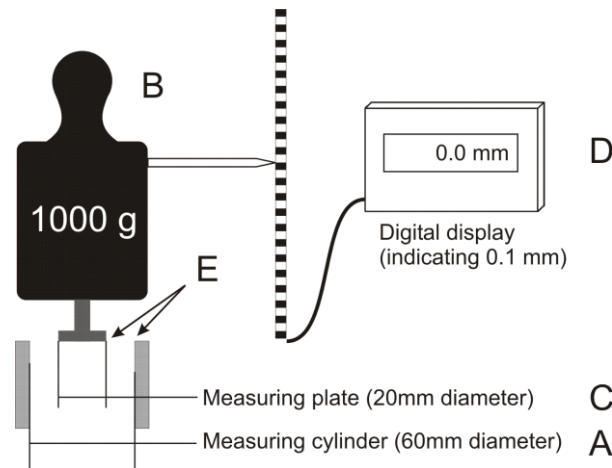

7.4.6.4.2.2 Measuring weight "B" presses measuring plate "C" onto the fabric/material which is laid flat, without stretching, on measuring cylinder "A". If the measuring cylinder is depressed at least 3 mm the material is acceptable.

7.4.6.4.2.3 If a figure below 3.0 is displayed the material is too stiff.

7.4.6.4.2.4 Follow-up controls after the competition (in Olympic Events after Qualifications) will be conducted by the Equipment control and supervised by the Jury. Follow-up controls must ensure that as many Finalists as possible are checked, together with a few random selections.

7.4.6.4.2.5 The check will be conducted immediately after the shooter has finished. If the clothing fails, it will be tested again after the first check. If any item of clothing fails a second time, the shooter must be disqualified.

7.4.6.4.2.6 Before and during all follow-up controls, the clothing must not be manipulated by heat or other temporary or permanent means.



7.4.7 Shooting Jacket

- 7.4.7.1** The body and sleeves of the jacket, including the lining, must not exceed 2.5 mm in single thickness and 5 mm in double thickness at any point where flat surfaces may be measured. The jacket must not be longer than the bottom of the balled fist (see Jacket Table).
- 7.4.7.2** Closure of the jacket must be only by non-adjustable means e.g. buttons or zippers. The jacket must not overlap more than 100 mm at the closure (see Jacket Table). The jacket must hang loosely on the wearer. To determine this, the jacket must be capable of being overlapped beyond the normal closure by at least 70 mm, measured from the center of the button to the outside edge of the button hole. The measurement will be taken with the arms at the sides. A measurement may be made either manually or with an ISSF approved overlap gauge with a tension of 6 kg to 8 kg. The area surrounding the button hole is limited to a maximum of 12 mm, and this area may exceed the permitted 2.5 mm thickness.
- 7.4.7.3** All straps, laces, bindings, seams, stitching or devices which may be construed as artificial support are prohibited. However it is permitted to have one zipper or not more than two straps to take up loose material in the area of the shoulder pad (see Jacket Table). No other zipper or other closing or tightening device is permitted other than those specified in these Rules and Diagrams.
- 7.4.7.4** The construction of the back panel may include more than one piece of material provided that this construction does not stiffen or reduce the flexibility of the jacket. All parts of the back panel must comply with the thickness limit of 2.5 mm when measured over a flat surface. All parts must comply with the stiffness limit.
- 7.4.7.5** In the prone and kneeling positions, the sleeve of the shooting jacket must not extend beyond the wrist of the arm on which the sling is attached. The sleeve must not be placed between the hand or glove and the fore-end of the stock when the shooter is in the shooting position.
- 7.4.7.6** No Velcro, sticky substance, liquid, or spray may be applied to the outside or inside of the jacket, pads or shoes and/or floor or equipment. Roughening the material of the jacket is permitted. Violations will be penalized according to the Rules.
- 7.4.7.7** Shooting jackets may have reinforcement patches added only to their outside surfaces subject to the following limitations:
- 7.4.7.7.1** Maximum thickness, including jacket material and all linings: 10 mm single thickness or 20 mm when measured as a double thickness.



- 7.4.7.7.2** Reinforcement may be added on both elbows but must not extend to more than half (1/2) of the circumference of the sleeve. On the arm which holds the sling, the reinforcement may extend from the upper arm to a point 100 mm from the end of the sleeve. The reinforcement on the opposite arm may have a maximum length of 300 mm.
- 7.4.7.7.3** Only one hook, loop, button or similar device may be fastened to the outside of the sleeve or shoulder seam on the sling arm to prevent the sling from sliding.
- 7.4.7.7.4** Reinforcement on the shoulder where the butt plate rests must not be longer than 300 mm in the longest dimension (see Jacket Table).
- 7.4.7.7.5** All inside pockets are prohibited. Only one (1) external pocket is permitted, located on the right front side (left front side for left hand shooters) of the jacket.
- 7.4.7.7.6** The maximum size of the pocket is 250 mm high from the lower edge of the jacket and 200 mm wide.
- 7.4.7.7.7**

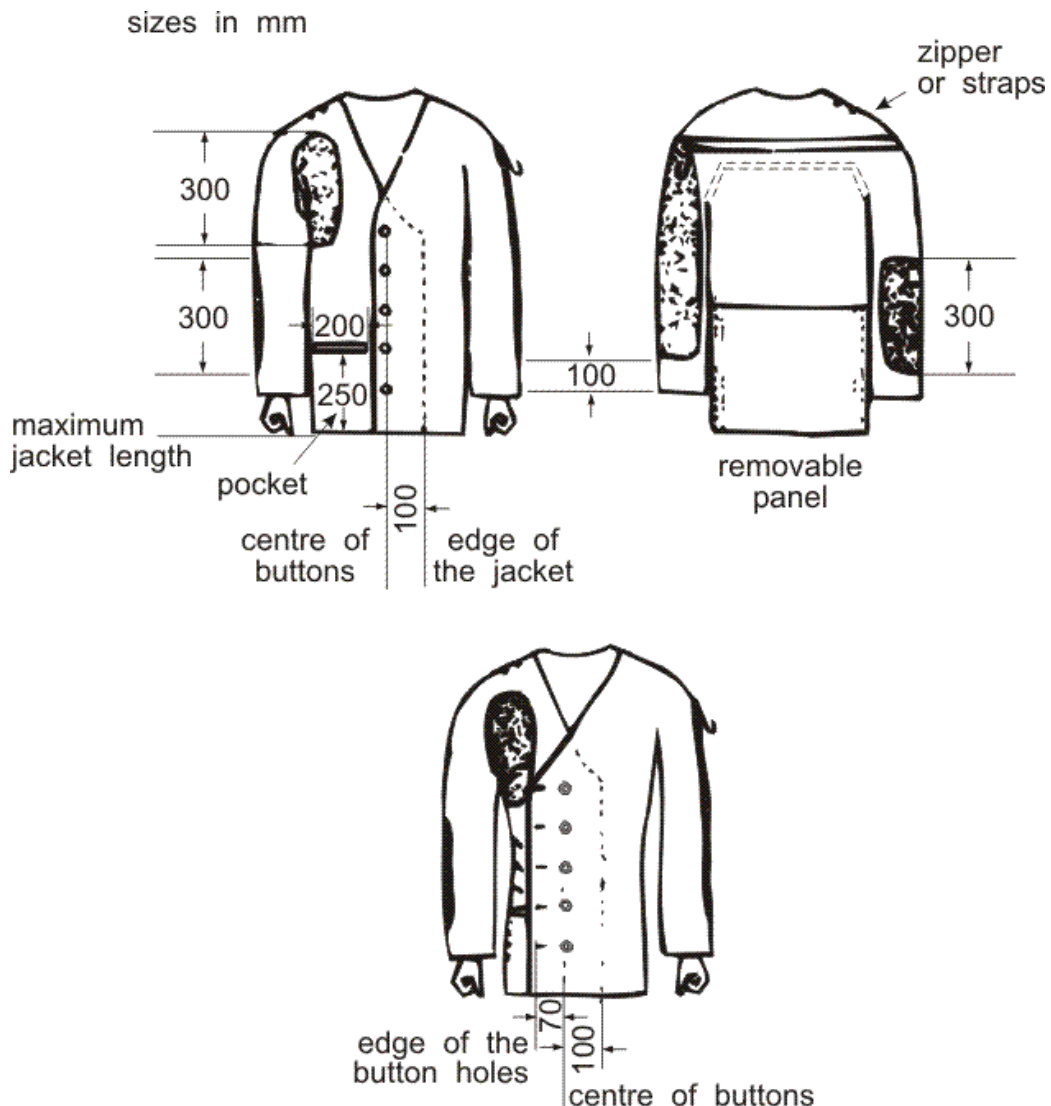



7.4.7.8 Shooting Trousers

- 7.4.7.8.1** The trousers, including the lining, must not exceed 2.5 mm in single thickness and 5 mm in double thickness at any point where flat surfaces may be measured. The top of the trousers must not fit or be worn higher on the body than 50 mm above the crest of the hipbone. All drawstrings, zippers or fasteners to tighten the trousers around the legs or hips are prohibited. To support the trousers only a normal waist belt not more than 40 mm wide and 3mm thick or braces (suspenders) may be worn. If a belt is worn in the standing position, the buckle or fastening must not be used to support the left arm or elbow. The belt must not be doubled, tripled etc. under the left arm or elbow. If the trousers have a waist band, it may not be more than 70 mm wide. If the thickness of the waistband exceeds 2.5 mm, a waist belt is not permitted. If a waist belt is not worn, the absolute maximum thickness of the waistband is 3.5 mm. Each belt loop (keeper) must not exceed 20 mm width. Shooting trousers may have a maximum of seven (7) belt loops, but there must be at least 80 mm of space between all belt loops. The trousers may be closed by one hook and up to five (5) eyes, or up to five (5) adjustable snap fasteners, or similar closure or Velcro which must not be multilayered. Only one type of closure is permitted. A Velcro closure combined with any other closure is prohibited. The trousers must be loose around the legs. If special shooting trousers are not worn, ordinary trousers may be worn providing they do not give artificial support to any part of the body.
- 7.4.7.8.2** Zippers, buttons, Velcro or similar non adjustable fasteners or closures, may be used in the trousers only in the following places:
- 7.4.7.8.2.1** One type of fastener or closure in the front to open and close the trousers fly. The fly must not be lower than the level of the crotch. Any holes that cannot be closed are permitted.
- 7.4.7.8.2.2** Only one other fastener is permitted in each trouser leg. The opening (fastener) must not start closer than 70 mm from the top edge of the trousers. It may, however, extend to the bottom of the trouser leg (see Jacket and Trousers Table). One fastener is permitted either in the front of the upper leg or the back of the leg, but not in both places in one leg.
- 7.4.7.8.2.3** Reinforcements may be added to the seat and both knees of the trousers. The seat patch must not exceed the width of the hips and be at least 150 mm below the top of the trousers waistband. Knee patches may have a maximum length of 300 mm. Knee reinforcements must not be wider than half the circumference of the trousers leg. The thickness of reinforcement including the trousers material and any linings must not exceed 10 mm in single thickness (20 mm double thickness). Stiffness may be measured over seat and knee pads if necessary. All pockets are prohibited.
- 7.4.7.8.2.4**

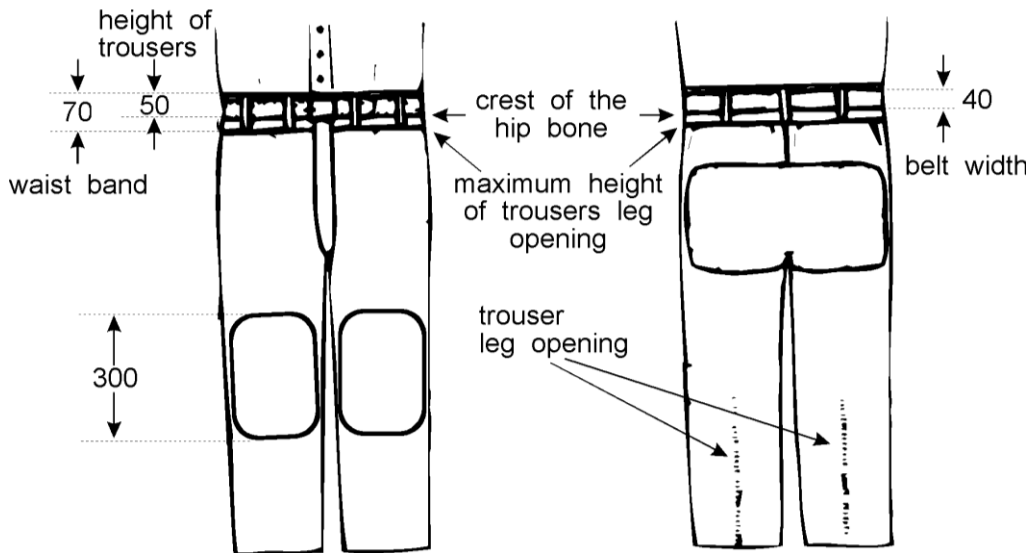

7.4.7.9 Shooting Gloves

7.4.7.9.1 The total thickness must not exceed 12 mm when measuring front and back materials together at any point other than on seams and joints.

7.4.7.9.2 The glove must not extend more than 50 mm beyond the wrist measured from the center of the wrist knuckle (Shooting Gloves). Any strap or other closure device at the wrist is prohibited. However, a portion of the wrist may be elasticated to enable the glove to be put on, but it must leave the glove loose around the wrist.

7.4.7.9.3

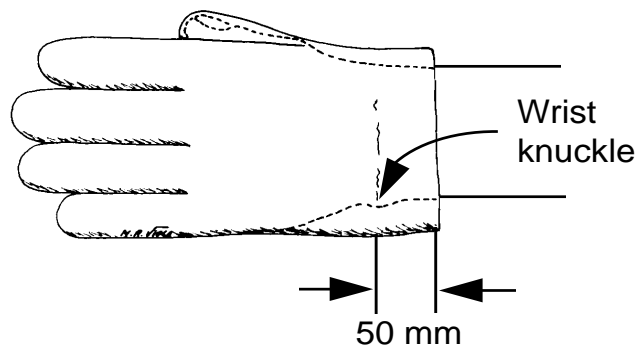

7.4.7.10 Dressing the Shooter

7.4.7.10.1 Clothing worn under the shooting jacket must not be thicker than 2.5 mm single thickness or 5 mm double thickness. The same applies to all clothing worn under the trousers. **Shooter underclothing will be checked as part of post competition testing.**



7.4.7.10.2 Only normal personal undergarments and/or training clothing that does not immobilize or unduly reduce the movement of the shooter's legs, body or arms may be worn under the shooting jacket and/or trousers. Any other undergarments are prohibited. Kinseio and medical taping are contrary to ISSF rule 6.4.2.1.1 and not permitted. Post competition testing will requires selected shooters to undress to confirm that they are not using banned taping.

7.4.7.11 Accessories

7.4.7.11.1 Spotting Telescopes

The use of telescopes not attached to the rifle to locate shots and to judge the wind is permitted for 50 m and 300 m events only.

USA 7.4.7.11.1A The use of telescopes not attached to the rifle to locate shots and to judge the wind is permitted 50m & 300m events only. The use of spotting telescopes is permitted at USAS sanctioned events.

7.4.7.11.2 Rifle Rests

The use of a rifle rest for resting the rifle between shots is permitted providing that it is not higher than the shooter's shoulders when standing normally. A stand for resting the rifle must not be placed in front of the shooting table in the standing position. A kneeling roll may be used as a rifle rest between shots. Care must be exercised that whilst resting the rifle, it does not intrude upon the adjacent shooter. For safety whilst the rifle is on the rifle rest, it must also be held by the shooter.

7.4.7.11.3 Shooting box or bag

The shooting box or bag must not be placed forward of the shooter's forward shoulder on the firing line, except that in the standing position a shooting box or bag, table, or stand may be used as a rifle rest between shots. The shooting box or bag, table or stand must not be of such size or construction as to interfere with shooters on adjacent points or to constitute a wind break.

7.4.7.11.4 Kneeling Roll

Only one cylindrically shaped roll is allowed for shooting in the kneeling position. The dimensions are a maximum of 25 cm long and 18 cm in diameter. It must be made of soft and flexible material. Binding or other devices to shape the roll are not permitted.

7.5 SHOOTING EVENT PROCEDURES AND COMPETITION RULES

7.5.1 Positions

7.5.1.1 Prone

7.5.1.1.1 The shooter may lie on the bare surface of the firing point or on the shooting mat.



- 7.5.1.1.2 He may also use the mat by resting his elbows on it.
- 7.5.1.1.3 The body must be extended on the firing point with the head toward the target.
- 7.5.1.1.4 The rifle may be supported by both hands and one shoulder only.
- 7.5.1.1.5 The cheek may be placed against the rifle stock.
- 7.5.1.1.6 The rifle may be supported by the sling but the forend behind the left hand must not touch the shooting jacket.
- 7.5.1.1.7 No part of the rifle may touch the sling or its attachments.
- 7.5.1.1.8 The rifle must not touch, or rest against, any other point or object.
- 7.5.1.1.9 Both forearms and sleeves of the shooting jacket forward of the elbow must be visibly raised from the surface of the firing point.
- 7.5.1.1.10 The shooter's sling (left) forearm must form an angle not less than 30 degrees from the horizontal, measured from the axis of the forearm.
- 7.5.1.1.11 The right hand and/or arm may not touch the left arm, shooting jacket or sling.
- 7.5.1.2 Standing**
- 7.5.1.2.1 The shooter must stand free with both feet on the firing point surface or on the shooting mat without any other support.
- USA 7.5.1.2.1A** A ground cloth can only be used if provided by the range. A personal ground cloth is not allowed.
- 7.5.1.2.2 The rifle may be held with both hands and the shoulder (upper right chest) or the upper arm near the shoulder and the part of the chest next to the right shoulder.
- 7.5.1.2.3 The cheek may be placed against the rifle stock.
- 7.5.1.2.4 The rifle must not touch the jacket or chest beyond the area of the right shoulder and right chest.
- 7.5.1.2.5 The left upper arm and elbow may be supported on the chest or on the hip. If a belt is worn the buckle or fastening must not be used to support the left arm or elbow.
- 7.5.1.2.6 The rifle must not touch or rest against any other point or object.
- 7.5.1.2.7 A palm rest may be used but not in 300 m Standard Rifle or Air Rifle events.
- 7.5.1.2.8 A hand stop/sling swivel is not allowed in this position for 300 m Standard Rifle and 10 m Air Rifle.
- 7.5.1.2.9 In this position, the use of the sling is prohibited.
- 7.5.1.2.10 The right hand may not touch the left hand, left arm or the left sleeve of the shooting jacket.
- 7.5.1.3 Kneeling**
- 7.5.1.3.1 The shooter may touch the firing point surface with the toe of the right foot, the right knee and the left foot.



- 7.5.1.3.2** The rifle may be held with both hands and the right shoulder.
- 7.5.1.3.3** The cheek may be placed against the rifle stock.
- 7.5.1.3.4** The left elbow must be supported on the left knee.
- 7.5.1.3.5** The point of the elbow must not be more than 100 mm over or 150 mm behind the point of the knee.
- 7.5.1.3.6** The rifle may be supported by the sling but the forend behind the left hand must not touch the shooting jacket.
- 7.5.1.3.7** No part of the rifle may touch the sling or its attachments.
- 7.5.1.3.8** The rifle must not touch or rest against any other point or object.
- 7.5.1.3.9** If the kneeling roll is placed under the instep of the right foot, the foot must not be turned at an angle of more than 45 degrees.
- 7.5.1.3.10** If the kneeling roll is not used, the foot may be placed at any angle. This may include placing the side of the foot and the lower leg in contact with the surface of the firing point.
- 7.5.1.3.11** No portion of the upper leg or buttocks may touch the surface of the firing point or shooting mat at any point.
- 7.5.1.3.12** If the shooter uses the shooting mat he may kneel completely on the shooting mat or may have one or two of three points of contact (toe, knee, foot) on the mat.
- 7.5.1.3.13** Only the trousers and underclothing may be worn between the shooter's seat and heel. The jacket or other articles must not be placed between these two points or under the right knee.
- 7.5.1.3.14** The right hand and/or arm may not touch the left hand, left arm or the left sleeve of the shooting jacket or sling.
- 7.6** **RIFLE EVENTS**
- See the Rifle Event Table 7.8
- 7.6.1** **Rifle events** should be programmed in the order 10 m, 50 m, and 300 m, however, when 300 m events are shot they must always be programmed after the 10 m and 50 m events.
- USA 7.6.1A** At USA Shooting sanctioned competitions: events maybe shot in any order
- 7.6.2** **Three position events** 50 m and 300 m must be fired in the following order: **Prone – Standing – Kneeling**
- 7.6.2.1** **Rifle 3x40**
- 7.6.2.2** All shooters must complete the prone stage before starting the standing stage, and all shooters must complete the standing stage before starting the kneeling stage.
- 7.6.2.3** The changeover time between positions is 10 minutes.
- 7.6.2.4** **SCORING PROCEDURES – Indication of shots 300 m**
- 7.6.2.5** **Pit Target Marking**



- 7.6.3** As soon as the Marker receives the signal, he must indicate the shot.
- 7.6.3.1** The **indication of shots** must be carried out in accordance with the following system. As soon as the Marker in the pit receives a signal for marking, he must:
- 7.6.3.1.1** **lower** the target;
 - 7.6.3.1.2** **cover** the hole with a transparent sticker and overlay a contrasting sticker to mark the location of the last shot;
 - 7.6.3.1.3** **raise** the target;
 - 7.6.3.1.4** **show** the value of the hit by the discing system.
- 7.6.3.2** When the spotting disc is used to indicate shot values, it must be done with a thin circular disc 200 mm to 250 mm in diameter. It is painted black on one side and white on the other and mounted on a thin staff which is normally fastened on the white side 30 mm to 50 mm to the right of the center.
- The **value** of hits will be shown as follows:
- 7.6.3.2.1** the position of the **last hit** must be marked;
 - 7.6.3.2.2** the value of the 1, 2, 3, 4, 5, 6, 7, and 8 hits must be shown by placing the disc, **black side toward the firing line**, on the appropriate spot on the target frame in the raised position as shown in the following figure;
 - 7.6.3.2.3** if the **hit is a nine**, the disc must be moved up and down twice over the black aiming bulls-eye on the target with the white side of the disc facing the firing line;
 - 7.6.3.2.4** if the **hit is a ten**, the disc, with the white side facing the firing line, must be moved twice in a clockwise circle in front of the black aiming mark, as shown in the following figure;
 - 7.6.3.2.5** a shot that does **not hit the target** is marked only by moving the black side of the marking disc three or four times sideways across the face of the target;
 - 7.6.3.2.6** if the hit is on the target card, but **not in the scoring area**, it is marked by first indicating a miss and then by showing the position of the hit.
 - 7.6.3.2.7** **Shot signaling diagram**

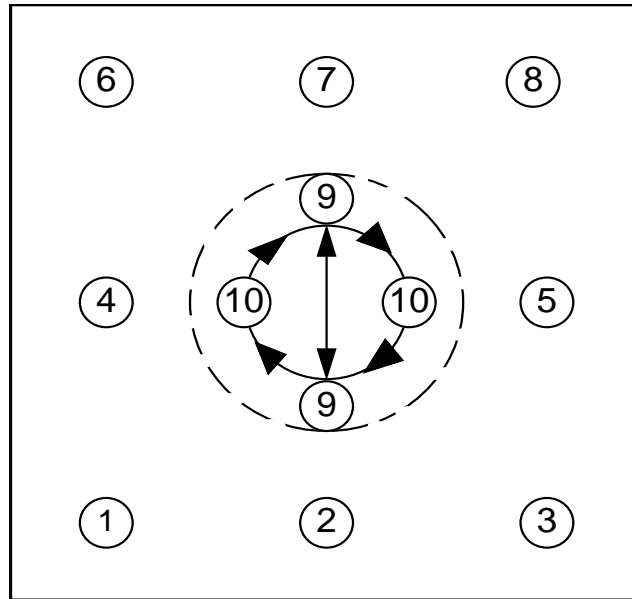

7.6.3.3

The sighting target must be marked clearly with a black diagonal stripe on the upper right hand corner of the target. The stripe must be clearly visible to the naked eye at the appropriate distance in normal light conditions. In the case of pit operated targets, the sighting target must not appear at all while the shooter is firing competition shots.



7.7 RIFLE EVENT TABLE

Event	Men/ Women	No. of shots	Number of shots per competition target (paper)	Number of sighting targets(paper)	Time pit operated or target carriers	Other systems
10 m Air Rifle	Men Women	60 40	1	4	1 hour, 45 minutes 1 hour, 15 minutes	1 hour, 45 minutes 1 hour, 15 minutes
50 m Rifle 3 Positions	Men	120	1	Each position 4	prone: 1 hour standing: 1 hour, 30 minutes kneeling: 1 hour, 15 minutes	45 minutes 1 hour, 15 minutes 1 hour
50 m Rifle 3 Positions	Women	60	1	Each position 4	2 hours, 30 minutes	2 hours, 15 minutes
50 m Rifle Prone	Men Women	60 60	1	4	1 hour, 30 minutes	1 hour, 15 minutes
300 m Rifle 3 Positions	Men	120	10	Each position 1	prone: 1 hour, 15 minutes standing: 1 hour, 45 minutes kneeling: 1 hour, 30 minutes	45 minutes 1 hour, 15 minutes 1 hour
300 m Rifle 3 Positions	Women	60	10	Each position 1	2 hours, 30 minutes	2 hours, 15 minutes
300 m Rifle Prone	Men Women	60 60	10	1	1 hour, 30 minutes	1 hour, 15 minutes
300 m Standard Rifle 3 Positions	Men	60	10	Each position 1	2 hours, 30 minutes	2 hours, 15 minutes
Note: The preparation period of 10 minutes starts before the published start time of the competition.						



7.8 RIFLE SPECIFICATION TABLE

Event	Maximum weight	Trigger	Maximum Length of the barrel/system	Ammunition	Thumb hole, thumb rest, palm rest, heel rest, spirit level	Other specifications
10 m Air Rifle	5.5 kg (men/women)	No set trigger	850 mm (system)	4,5 mm (.177")	No	No bipod
50 m Rifle 3 Positions and Prone	8.0 kg (men)	No restriction	No restriction	5.6 mm (.22") Long Rifle	Yes – palm rest only standing	
50 m Rifle 3 Positions and Prone	6.5 kg (women)	No restriction	No restriction	5.6 mm (.22") Long Rifle	Yes – palm rest only standing	
300 m Rifle 3 Positions and Prone	8.0 kg (men)	No restriction	No restriction	Maximum 8 mm	Yes – palm rest only standing	Maximum width of mirage band = 60 mm.
300 m Rifle 3 Positions and Prone	6.5 kg (women)	No restriction	No restriction	Maximum 8 mm	Yes – palm rest only standing	Maximum width of mirage band = 60 mm.
300 m Standard Rifle 3 Positions	5.5 kg (men)	No set trigger Minimum trigger pull: 1500g	762 mm (barrel)	Maximum 8 mm	No	Maximum width of mirage band = 60 mm. No bipod or attached rifle rest.
Note: The rifle must be weighed with all accessories (including palm rest or hand stop if used).						



7.9 INDEX RIFLE RULES

10 m Air Rifle	7.4.2.5
300 m Rifle	7.4.4
300 m Standard Rifle	7.4.2.4
50 m Rifle	7.4.3
50 m Rifles for men / women	7.4.3.1
Accessories	7.4.7.11
Addition to stock 300 m Standard Rifle and 10 m Air Rifle	7.4.2.2
Aiming left – Shooting right / aiming right – shooting left	7.4.1.3.5
Ammunition	7.4.5
Application of Rules for all Rifle events	7.1.1
Barrel – length – 300 m Standard Rifle	7.4.2.4.4
Barrels	7.4.1.2
Blinder – On the rear sight	7.4.1.3.4
Butt plate – 50 m Rifle / 300 m Rifle	7.4.3.2
Butt plate – Offset on 300 m Standard Rifles / 10 m Air Rifles	7.4.2.1
Change or more than one part of a rifle – 50 m Rifle / 300 m Rifle	7.4.3.4
Change a rifle – 300 m Standard Rifle	7.4.2.4.3
Change or more than 1 rifle – 50 m Rifle / 300 m Rifle	7.4.3.4
Changeover – Rifle 3x40	7.6.3.2
Characteristics of shooting clothing	7.4.6.2
Check after competition / qualification	7.4.6.4.2.5
Clothing Regulations	7.4.6
Clothing under the jacket and trousers	7.4.7.10.1
Compensators	7.4.1.2.1
Correcting lenses	7.4.1.3.1
Correction glasses	7.4.1.3.2
Device inside barrels / tubes	7.4.1.2
Dressing the shooter	7.4.7.10
Electronic triggers	7.4.1.4
Equipment and Ammunition	7.4
Exterior Weights – 300 m Standard Rifle / 10 m Air Rifle	7.4.2.3
Follow-up controls after competition / qualification	7.4.6.4.2.4
General Rifle	7.1
Heel rest – 300 m Standard Rifle / 10 m Air Rifle	7.4.2.2
Heel rest – 300 m Standard Rifle / 10 m Air Rifle	7.4.2.2.2
Hook – 50 m Rifle / 300 m Rifle	7.4.3.2
Immobilize or reduce the movement	7.4.7.10.2
Increased grip material – 300 m Standard Rifle / 10 m Air Rifle	7.4.2.2.1
Indication of shots 300 m – paper targets	7.7
Kneeling	7.5.1.3
Kneeling roll	7.4.7.11.4



Knowledge of the Rules	7.1.2
Left-handed shooter – Right-handed shooter	7.1.3
Length of barrel – 300 m Standard Rifle	7.4.2.4.4
Length of rifle system –10 m Air Rifle	7.4.2.5.2
Lenses	7.4.1.3.3
Light filters	7.4.1.3.3
Manipulation of material after examination	7.4.6.2.1.3
Manipulation of material before or during the follow-up controls	7.4.6.4.2.6
Mark on shooting clothes which 3 times fail the equipment control	7.4.6.2.1
Material for shooting jackets, shooting trousers, shooting gloves	7.4.6.2
Measuring Devices	7.4.6.4
Men's events	7.1.4
Muzzle brakes	7.4.1.2.1
Number of failures of shooting clothes at the equipment control	7.4.6.2.1
Number of shooting jackets, shooting shoes and shooting trousers	7.4.6.2.1
One-time inspection	7.4.6.1
Palm rest – 300 m Standard Rifle / 10 m Air Rifle	7.4.2.2
Palm rest – 50 m Rifle / 300 m Rifle	7.4.3.3
Perforation of barrels / tubes	7.4.1.2
Permanent alteration of clothing	7.4.6.2.1
Permanent alteration of clothing	7.4.6.2.1.2
Pistol Grips	7.4.1.1
Positions	7.5.1
Program Order	7.6.1
Prone	7.5.1.1
Range and Target Standards	7.3
Reinforcements	7.4.7.8.2.3
Reinforcements – Table	7.4.6.4.1.1
Removing from the firing line – 300 m Standard Rifle	7.4.2.4.2
Rests – Rifle Rests	7.4.7.11.2
Rifle 3x40	7.6.3
Rifle Events - See the Rifle Event Table 7.8.0	7.8
Rifle Measurement Table – 300 m Standard Rifle / 10 m Air Rifle	7.4.2.6
Rifle Measurements – 300 m Standard Rifle / 10 m Air Rifle	7.4.2.7
Right-handed shooter – Left-handed shooter	7.1.3
Safety	7.2
Scoring Procedures – Indication of shots 300 m	7.7
Shooting box / shooting bag	7.4.7.11.3
Shooting Events Procedures and Competition Rules	7.5
Shooting gloves	7.4.7.9
Shooting gloves – Closure	7.4.7.9.2
Shooting gloves – Thickness	7.4.7.9.1
Shooting jacket	7.4.7



Shooting jacket – Artificial support; straps, laces, stitching, etc...	7.4.7.3
Shooting jacket – Body, sleeves, length	7.4.7.1
Shooting jacket – Closure: non-adjustable	7.4.7.2
Shooting jacket – Construction of the back panel	7.4.7.4
Shooting jacket – Drawing	7.4.7.7.7
Shooting jacket – Fastening of sling	7.4.7.7.3
Shooting jacket – Loose material in the area of the shoulder	7.4.7.3
Shooting jacket – Overlapping, hanging loosely	7.4.7.2
Shooting jacket – Pocket	7.4.7.7.5
Shooting jacket – Position of the sleeve	7.4.7.5
Shooting jacket – Reinforcements	7.4.7.7
Shooting jacket – Reinforcements: butt plate rest on the shoulder	7.4.7.7.4
Shooting jacket – Reinforcements: elbows	7.4.7.7.2
Shooting jacket – Reinforcements: maximum thickness	7.4.7.7.1
Shooting jacket – Roughening	7.4.7.6
Shooting jacket – Size of pocket	7.4.7.7.6
Shooting jacket – Use of sticky substance, liquid, etc...	7.4.7.6
Shooting left – Aiming right / shooting right – aiming left	7.4.1.3.5
Shooting shoes	7.4.6.3
Shooting shoes – Drawing and table	7.4.6.3.4.1
Shooting shoes – Height	7.4.6.3.3
Shooting shoes – Matched pair	7.4.6.3.4
Shooting shoes – Material sole	7.4.6.3.2
Shooting shoes – Material upper part	7.4.6.3.1
Shooting trousers	7.4.7.8
Shooting trousers – Braces (suspenders)	7.4.7.8.1
Shooting trousers – Closure devices	7.4.7.8.2
Shooting trousers – Closure devices: trousers fly	7.4.7.8.2.1
Shooting trousers – Closure devices: trousers leg	7.4.7.8.2.2
Shooting trousers – Drawing	7.4.7.8.2.4
Shooting trousers – Draw-strings, zippers, fasteners	7.4.7.8.1
Shooting trousers – Loose around the legs	7.4.7.8.1
Shooting trousers – Reinforcements	7.4.7.8.2.3
Shooting trousers – Thickness	7.4.7.8.1
Shooting trousers – Top of trousers	7.4.7.8.1
Shooting trousers – Waist band: wide, closure devices	7.4.7.8.1
Shooting trousers – Waist belt	7.4.7.8.1
Shooting trousers – Waist belt: support the arm or elbow	7.4.7.8.1
Sights	7.4.1.3
Sights – Lenses, lenses system, light filters	7.4.1.3.3
Slings	7.4.1.4.5
Spirit level – 300 m Standard Rifle / 10 m Air Rifle	7.4.2.2
Spotting telescopes	7.4.7.11.1



Standards for 300 m Standard Rifle / 10 m Air Rifle	7.4.2
Standards for all Rifles	7.4.1
Standing	7.5.1.2
Stiffness	7.4.6.4.2
Substitution of clothing	7.4.6.2.1.1
Telescopes	7.4.1.3.1
Telescopes	7.4.7.11.1
Temporarily alteration of clothing	7.4.6.2.1.2
Thickness	7.4.6.4.1
Thickness – Table	7.4.6.4.1.1
Three positions – Firing order	7.6.2
Thumb hole – 300 m Standard Rifle / 10 m Air Rifle	7.4.2.2
Thumb rest – 300 m Standard Rifle / 10 m Air Rifle	7.4.2.2
Trigger Pull – 300 m Standard Rifle	7.4.2.4.1
Women's events	7.1.4